

WSSC - Serisi ISO 6432 Silindirler / WSSC - Series ISO 6432 Cylinders

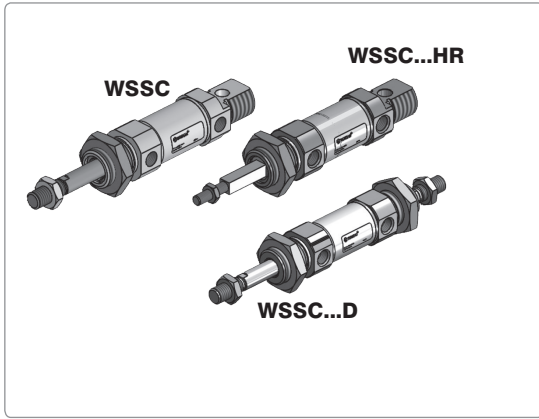

Piston Çapı / Bore Size	8	10	12	16	20	25	32	40
Çalışma Tipi / Acting Type	Çift Etkili / Double Acting							
Akışkan / Fluid	Hava (40µm filtrelenmiş) / Air (40µm filtered)							
Çalışma Basıncı / Op. Pressure	< 10 Bar							
Sıcaklık / Temperature	0 ~ +80 °C							
Manyetik / Magnetic	Opsiyonel / Optional							
Yastıklama Tipi / Cush. Type	-				Ayarlı Yast. / Adjustable Cush.			
Hız / Speed Range	< 800 mm/s							
Sensör / Sensör Switches	WT-05/WT-15 + BK81				WT-50 + BL01			

Teknik Çizim / Technical Drawing

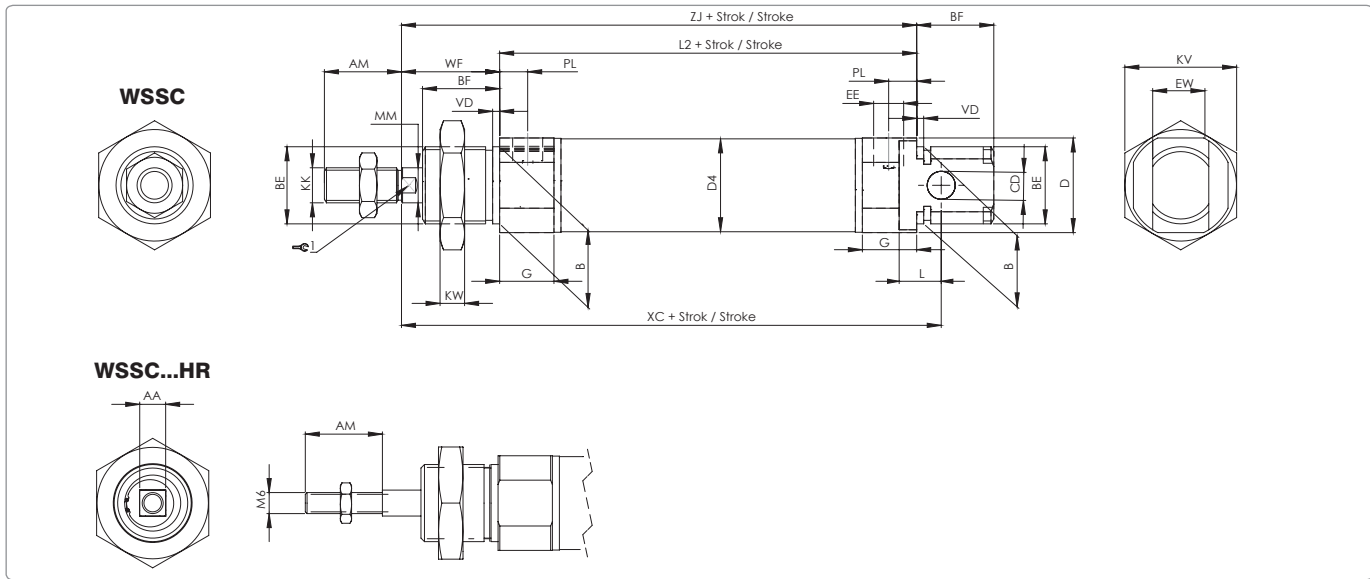

Ø mm	AM	B Ø h9	BE	BF	CD Ø h9	D Ø	D4 Ø	EE	EW	G	KK	KV	KW	L	L2	MM Ø	PL	VD	WF ±1,2	XC ±1	ZJ	ZM	ZN	AA	1	YASTIKLAMA BOYU	STANDART MAX. BOY
8	12	12	M12X1.25	12	4	16	9.30	M5	8	9	M4X0.70	15	6	6	46	4	6	2	16	64	62	78	62	-	-	-	200
10	12	12	M12X1.25	12	4	16	11.30	M5	8	9	M4X0.70	15	6	6	46	4	6	2	16	64	62	78	62	-	-	-	200
12	16	16	M16X1.50	17	6	20	13.30	M5	12	9	M6X1.00	19	8	9	50	6	6	2	22	75	72	94	72	-	5	-	250
16	16	16	M16X1.50	17	6	20	17.30	M5	12	10.50	M6X1.00	22	8	9	56	6	6	2	22	82	78	100	78	-	5	13.0	250
20	20	22	M22X1.50	18	8	30	21.30	G1/8	16	15.50	M8X1.25	27	11	12	68	8	6	2	22	95	72	94	72	7,4	5	12,5	400
25	22	22	M22X1.50	22	8	30	26.50	G1/8	16	15.50	M10X1.25	27	11	12	69	10	8	2	28	104	97,50	120	92	7,4	9	11,5	500
32	22	30	M30X1.50	26	10	41	33,6	G1/8	16	19	M10X1.25	42	8	13	69,5	12	9	2	34	117,5	103,5	-	-	-	10	-	-
40	24	38	M38X1.50	30	12	49	41,6	G1/4	16	25	M12X1.25	50	10	15	84,6	16	12	3	39	139,6	123,6	-	-	-	13	-	-

Sipariş Kodu / Ordering Code

MODEL	OPSİYON OPTIONS	MANYETİK MAGNETIC	YASTIKLAMA CUSHIONING	ÇAP DIA.	STROK STROKE	MİL UZUNLUĞU ROD LENGHT	DİŞ TİPİ SCREW TYPE	DİŞ ÖLÇÜSÜ SCREW SIZE	DİŞ UZUNLUĞU SCREW LENGHT	
WSSC	D	M	YY	025	0050	L25	F	ZM8.H1.0	E15	
	BOŞ : STANDART D : ÇİFT MİLLİ J : STROK AYARLI HR : DÖNMEZ MİLLİ FS : ÖNDEN YAYLI (50mm ye Kadar) RS : ARKADAN YAYLI (50mm ye Kadar) V : SICAĞA DAYANIKLI (150° Sıcaklığa Kadar)	- Blank Standart - Double Rod - Stroke Adjustable - Hegzagonal Roc - Front Spring (Up to 50mm) - Rear Spring (Up to 50mm) - Heat Resistance (Up to 150°C)	BOŞ : MANYETİKSİZ Blank : Without Magnet YY : YASTIKLI YY : Cushioned	BOŞ : YASTIKSIZ Blank : Uncushioned	PISTON ÇAP (mm) Piston Dia	STROK (mm) Stroke	LX (mm) -	F : DİŞİ Female BOŞ : STANDART Blank : Standart	Zx : ÇAP Dia Hx : HATVE Pitch BOŞ : STANDART Blank : Standart	Ex (mm) BOŞ : STANDART Blank : Standart

WSSC - Serisi ISO 6432 Silindirler / WSSC - Series ISO 6432 Cylinders

Çift Milli Silindirler / Trough Rod Cylinders

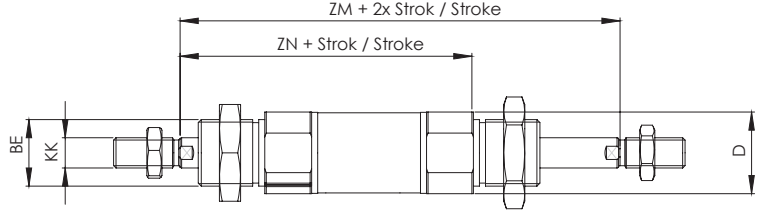
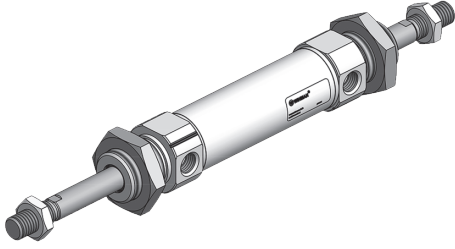
WSSC.M.YY.025.0050.D
 $\frac{\text{Ø}}{\text{Strok / Stroke}}$

Önden Yaylı Silindirler / Single Act. Front Spring Cylinders

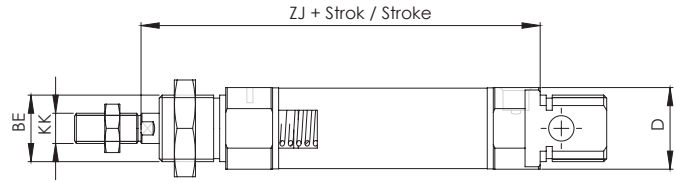
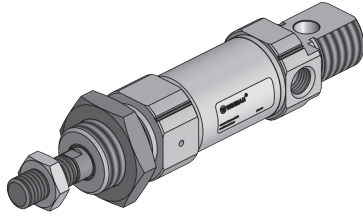
WSSC.M.YY.025.0050.FY
 $\frac{\text{Ø}}{\text{Strok / Stroke}}$

 50 mm kurs üzeri için bilgi alınız.
 Contact us above 50 mm stroke

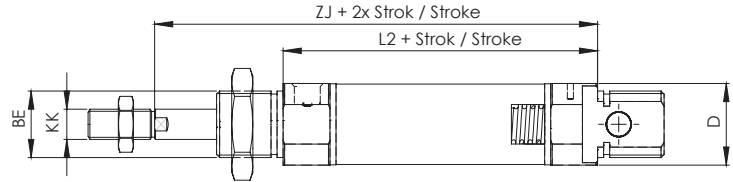
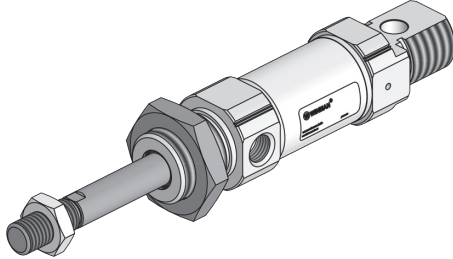
Arkadan Yaylı Silindirler / Rear Spring Cylinders

WSSC.M.YY.025.0050.RY
 $\frac{\text{Ø}}{\text{Strok / Stroke}}$

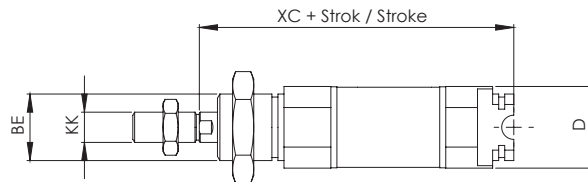
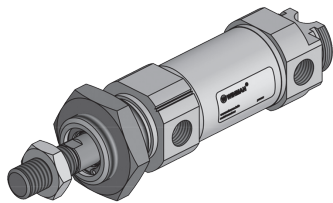
 50 mm kurs üzeri için bilgi alınız.
 Contact us above 50 mm stroke

Kısaltılmış Silindirler / Short Cap Cylinders

WSSC.M.YY.025.0050.K3
 $\frac{\text{Ø}}{\text{Strok / Stroke}}$

Ø mm	ZM	ZN	ZJ	L2	XC ±1	BE	KK	D Ø
8	78	62	62	46	64	M12X1.25	M4X0.70	16
10	78	62	62	46	64	M12X1.25	M4X0.70	16
12	94	72	72	50	75	M16X1.50	M6X1.00	20
16	100	78	78	56	82	M16X1.50	M6X1.00	20
20	116	92	92	68	95	M22X1.50	M8X1.25	30
25	120	92	97.50	69	104	M22X1.50	M10X1.225	30